

迈斯维高增益WiFi6E天线线螺母+3M泡棉胶安装 IP67防水

AN_W_401B

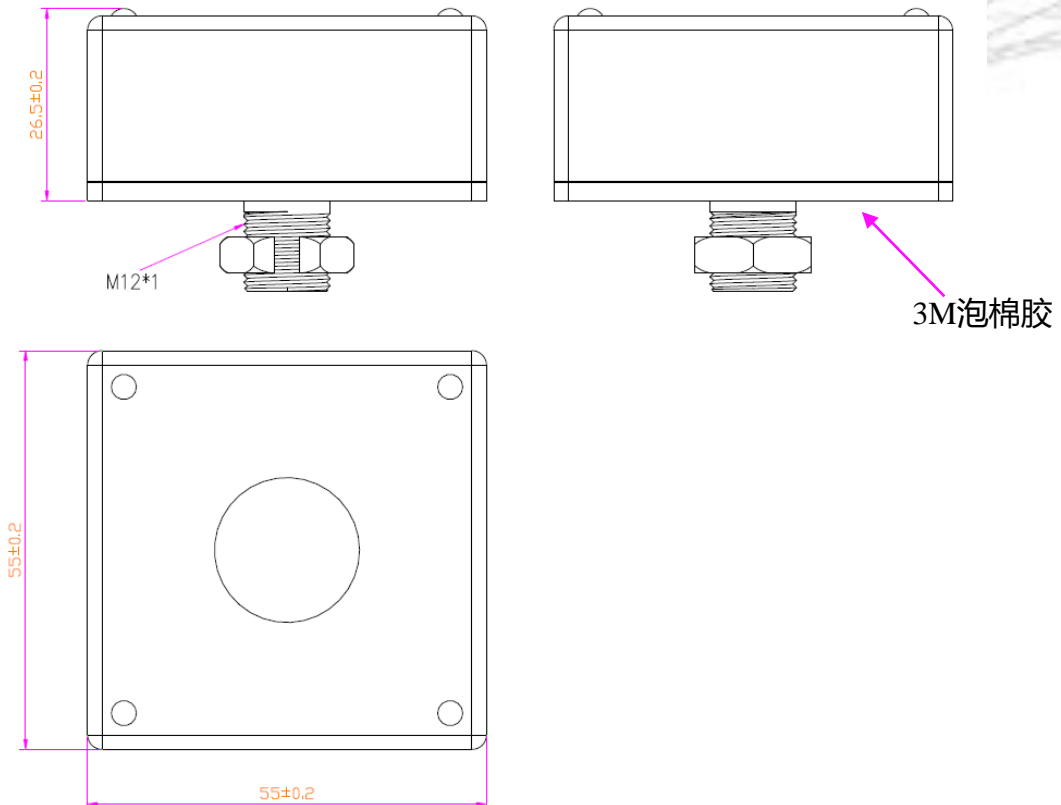

机械尺寸



迈斯维高增益WiFi6E天线线螺母+3M泡棉胶安装 IP67防水

AN_W_401B

规格

项目	规格	
天线	中心频率	2100MHz-7200MHz
	极化	线性
	增益	4dBi
	V.S.W.R	< 1.5
	阻抗	50Ω
	尺寸	55 *55 *26.5mm
机械	电缆	RG174 (3M)
	连接器	SMA 或其他 (可定制)
	天线罩材料	ASA
	安装方法	螺母+3M泡棉胶
环境	工作温度	-40°C~+85°C
	相对湿度	高达95%
	防水等级	IP67 (欧盟标准IP67 EN 60529:1991+A1:2000+A2:2013+AC:2019 中国国标GB/T4208-2017)
	振动	10至55Hz, 1.5mm振幅, 2小时
	环保	符合ROHS标准
	防紫外线	是

迈斯维高增益WiFi6E天线线螺母+3M泡棉胶安装 IP67防水

AN_W_401B

测试结果

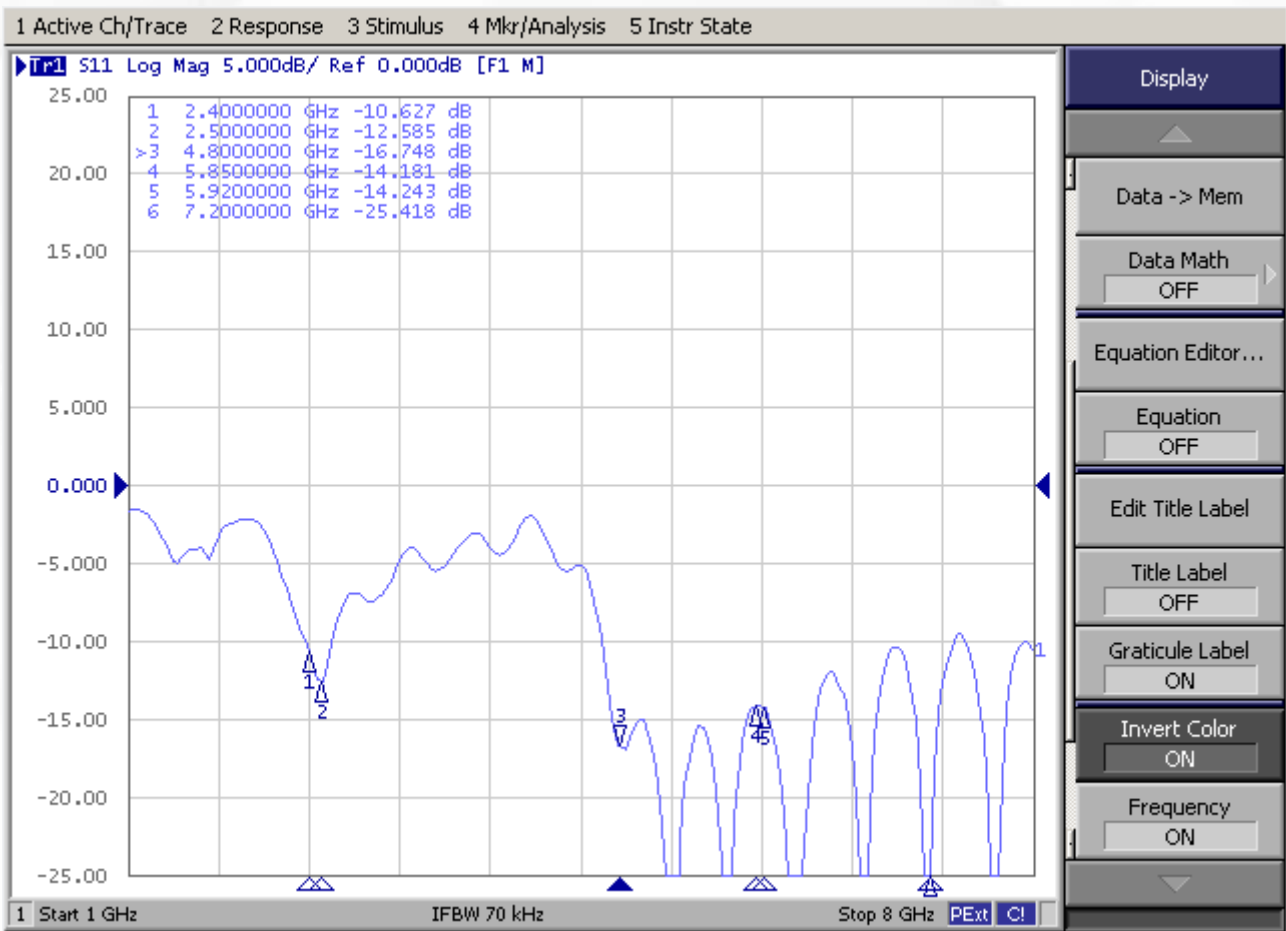

迈斯维高增益WiFi6E天线线螺母+3M泡棉胶安装 IP67防水

AN_W_401B

实测数据

Passive Test For 5000-7500		
Freq (MHz)	Effi (%)	Gain (dBi)
5000	68.55	3.11
5050	64.32	2.8
5100	65.8	3.14
5150	64.29	3.12
5200	58.93	2.78
5250	61.5	3.06
5300	58.83	2.81
5350	61.24	2.69
5400	63.38	2.99
5450	61.58	2.93
5500	62.57	3.44
5550	63.01	3.51
5600	60.6	3.46
5650	62.68	3.58
5700	62.69	3.14
5750	64.56	2.92
5800	63.55	2.66
5850	68.75	2.79
5900	63.69	2.14
5950	83.06	3.06
6000	76.5	2.06
6050	71.26	3.3
6100	85.68	3.07

Passive Test For 5000-7500		
6150	81.72	2.79
6200	73.33	2.32
6250	64.96	1.77
6300	61.87	1.65
6350	59.18	1.63
6400	60.11	1.65
6450	60.07	1.68
6500	65.13	1.97
6550	73.29	2.46
6600	76.18	2.71
6650	78.5	2.81
6700	85.03	3.46
6750	75.72	2.86
6800	68.03	2.38
6850	73.76	2.79
6900	72.38	3.25
6950	73.42	3.64
7000	75.81	4.31
7050	76.94	4.33
7100	74.5	4.49
7150	69.02	4.04
7200	65.27	3.44
7250	62.95	3.32
7300	60.34	3.54
7350	57.64	4.02
7400	64.98	4.8
7450	62.27	4.86
7500	65.99	4.91

迈斯维高增益WiFi6E天线线螺母+3M泡棉胶安装

IP67防水

AN_W_401B

Passive Test For 2110-2750			Passive Test For 2110-2750		
Freq (MHz)	Effi (%)	Gain (dBi)			
			2410	71.64	5.16
			2420	71.19	5.13
2110	27.86	-0.33	2430	66.76	4.83
2120	31.52	0.51	2440	68.06	4.93
2130	36	1.3	2450	65.01	4.74
2140	34.11	1.18	2460	65.37	4.75
2150	30.49	0.8	2470	61.31	4.39
2160	32.35	1.22	2480	61.7	4.4
2170	37.58	2.12	2490	66.43	4.69
2180	41.83	2.7	2500	68.42	4.87
2190	37.83	2.33	2510	65.55	4.72
2200	37.87	2.45	2520	60.73	4.39
2210	39.82	2.78	2530	62.35	4.5
2220	48.74	3.76	2540	63.31	4.58
2230	50.48	3.91	2550	66.62	4.8
2240	48.19	3.67	2560	63.87	4.56
2250	46.2	3.51	2570	63.83	4.53
2260	53.46	4.13	2580	61.63	4.44
2270	62.06	4.76	2590	63.84	4.61
2280	61.33	4.67	2600	63.65	4.58
2290	58.24	4.46	2610	61.01	4.36
2300	58.64	4.51	2620	56.14	3.97
2310	65.88	4.99	2630	58.41	4.02
2320	70.62	5.3	2640	62.19	4.34
2330	73.05	5.39	2650	62.32	4.39
2340	70.05	5.13	2660	60.58	4.29
2350	72.05	5.16	2670	58.92	4.1
2360	73.64	5.19	2680	61.49	4.29
2370	71.99	5.09	2690	59.01	4.15
2380	71.29	5.04	2700	57.87	4.04
2390	69.83	4.98	2710	53.66	3.76
2400	71.92	5.13	2720	53.84	3.85
			2730	52.64	3.79
			2740	54.58	3.99
			2750	53.72	3.92

迈斯维高增益WiFi6E天线线螺母+3M泡棉胶安装 IP67防水 AN_W_401B

2400Mhz

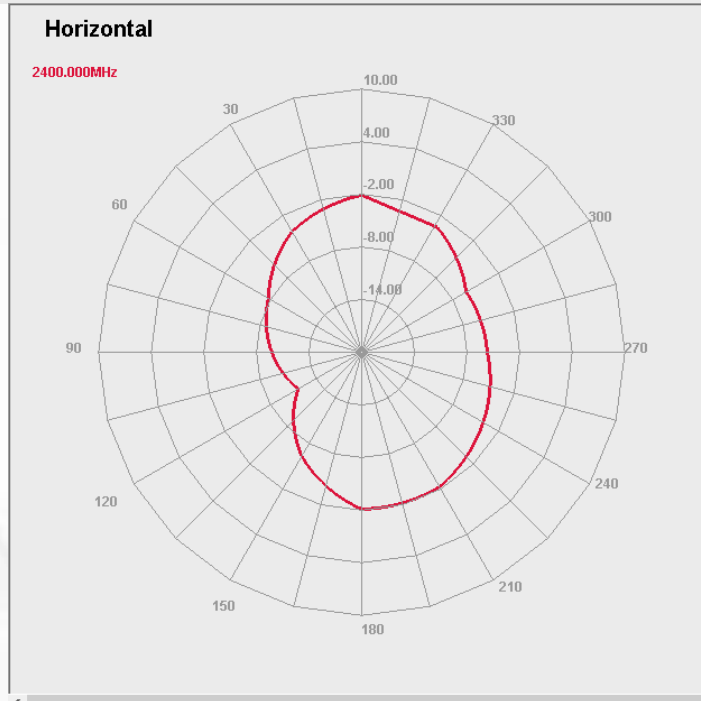

迈斯维高增益WiFi6E天线线螺母+3M泡棉胶安装 IP67防水

AN_W_401B

5000Mhz

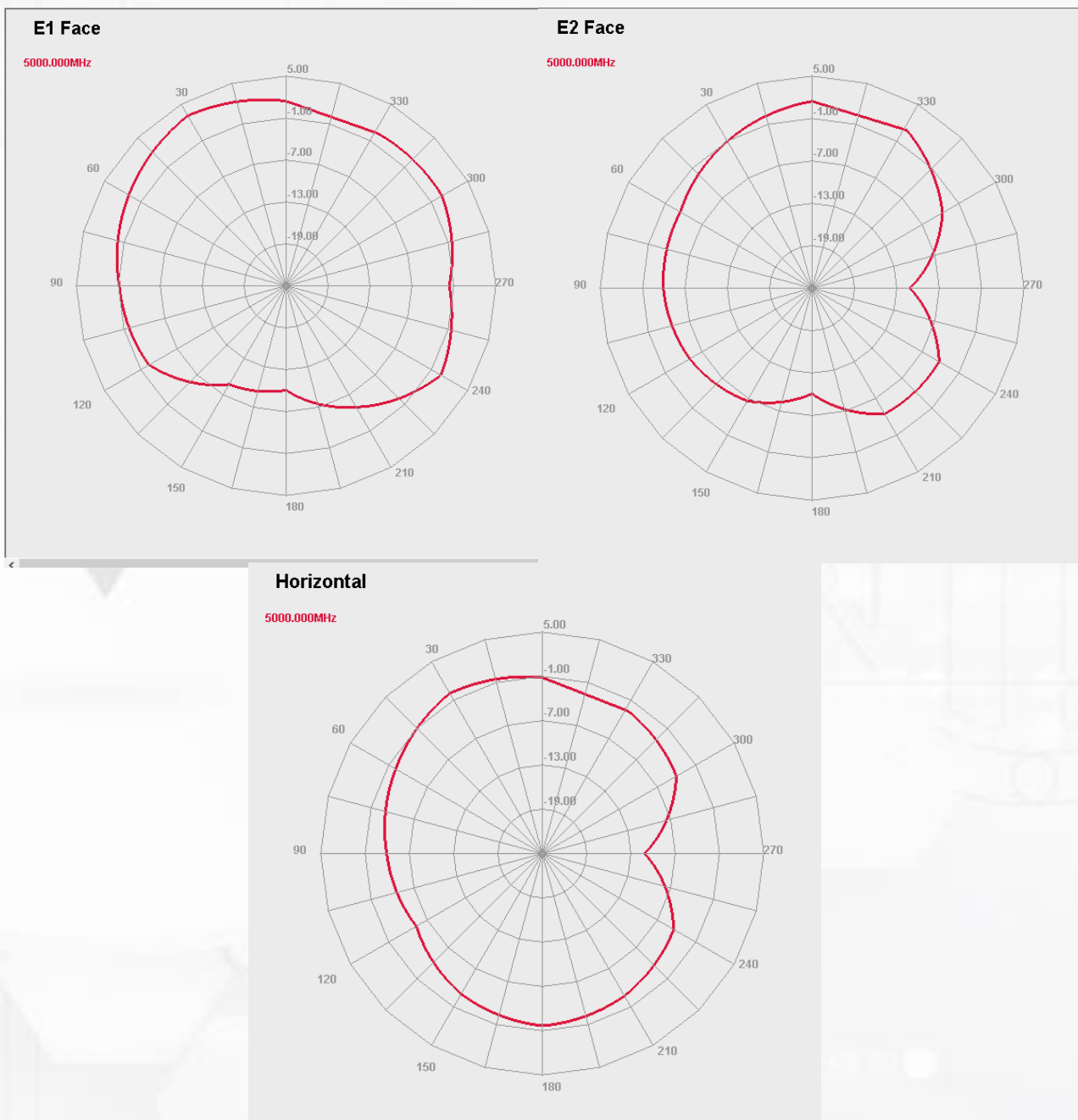

迈斯维高增益WiFi6E天线线螺母+3M泡棉胶安装 IP67防水

AN_W_401B

5800MHz

E1 Face

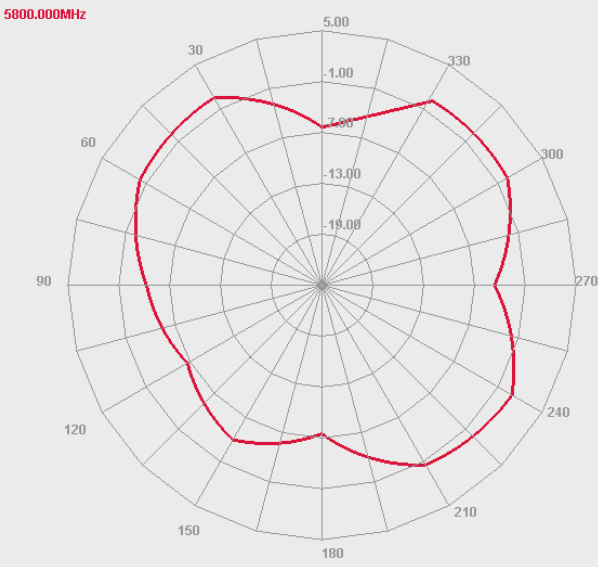

E2 Face

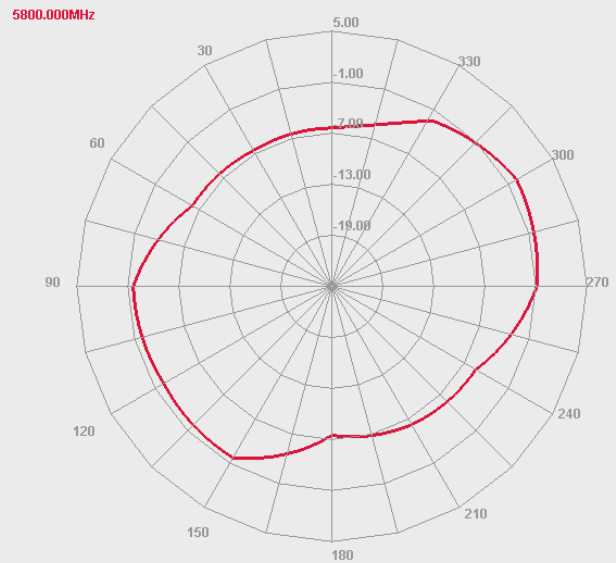

Horizontal

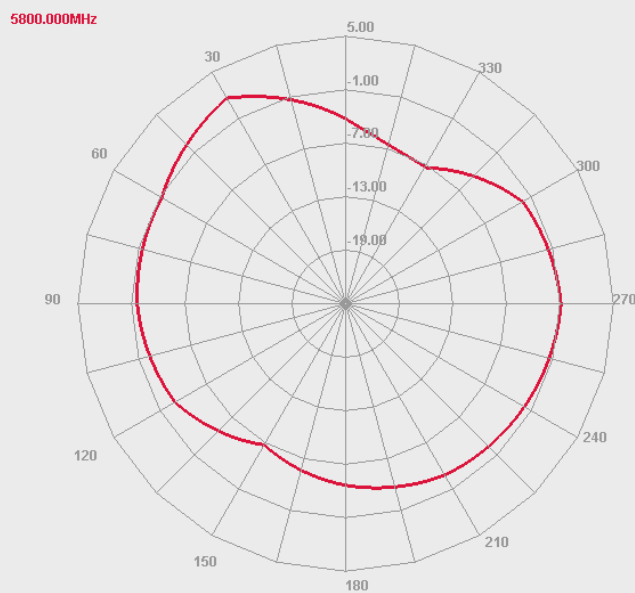

迈斯维高增益WiFi6E天线线螺母+3M泡棉胶安装 IP67防水

AN_W_401B

7100MHz

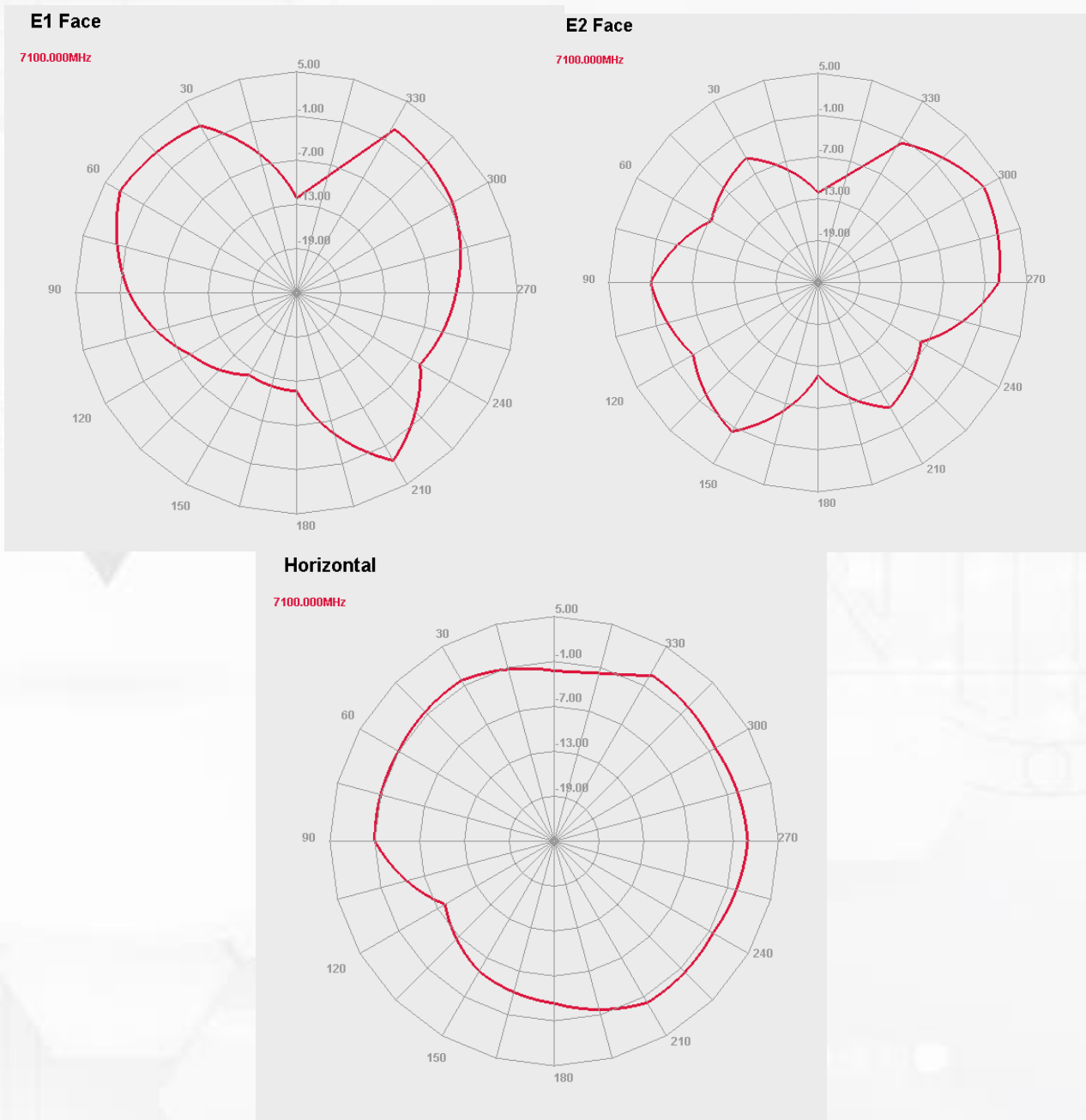

迈斯维高增益WiFi6E天线线螺母+3M泡棉胶安装 IP67防水

AN_W_401B

2110.00MHz - 2750.00MHz Gain

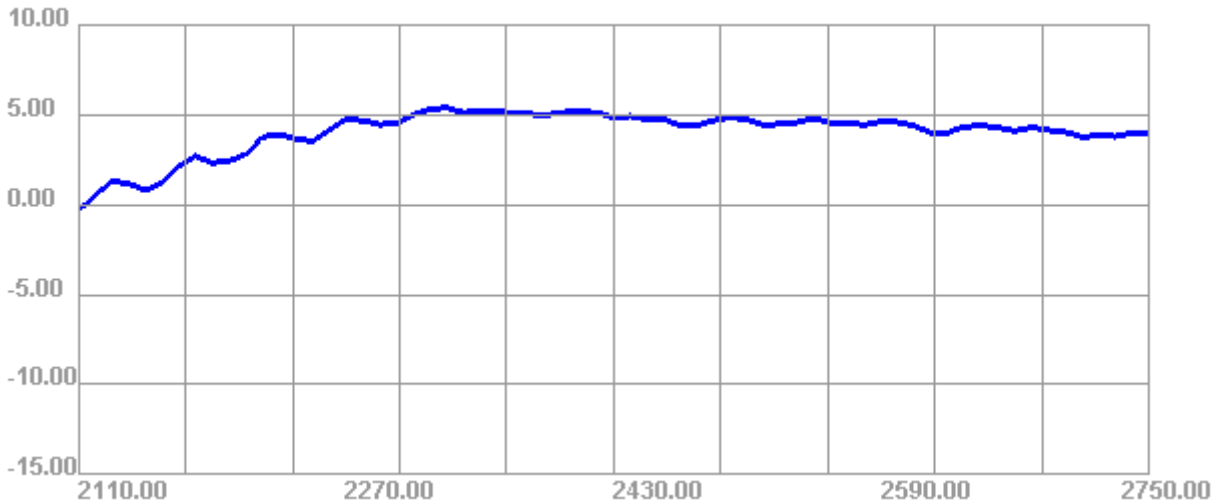

2110.00MHz - 2750.00MHz Efficiency



迈斯维高增益WiFi6E天线线螺母+3M泡棉胶安装 IP67防水

AN_W_401B

5000.00MHz - 7500.00MHz Gain

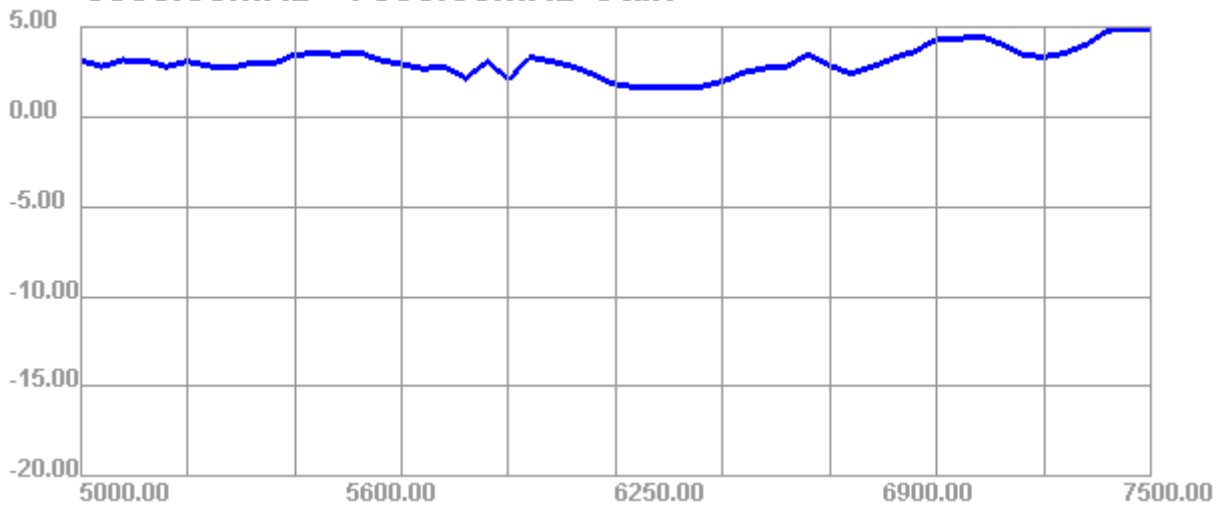

5000.00MHz - 7500.00MHz Efficiency

