

# 迈斯维高增益蜂窝天线700-6000MHz支持 5G/4G/WiFi6 IP67防紫外线螺母3M双安装

AN\_GSM\_401

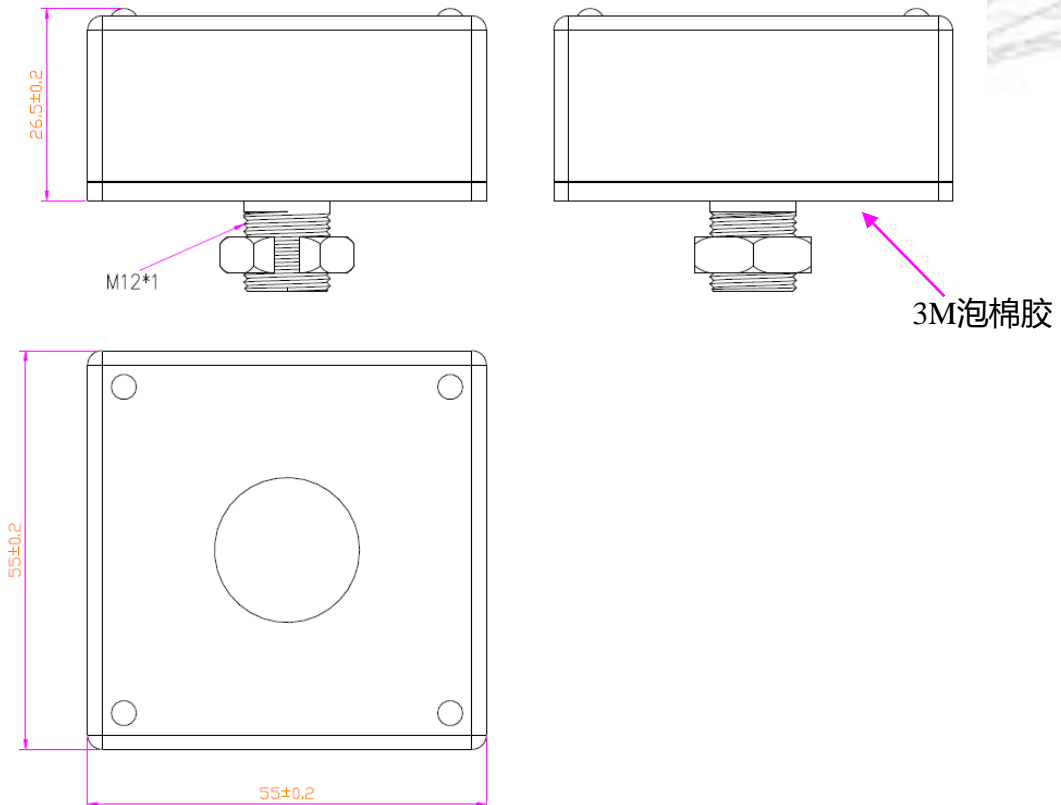

## 机械尺寸



# 迈斯维高增益蜂窝天线700-6000MHz支持 5G/4G/WiFi6 IP67防紫外线螺母3M双安装

AN\_GSM\_401

## 规格

项目	规格	
天线	中心频率	700-6000Mhz
	极化	线性
	增益	5dBic@PCB (最高点)
	V.S.W.R	< 1.5
	阻抗	50Ω
	尺寸	55 *55 *26.5mm
机械	电缆	RG174 (3M)
	连接器	SMA 或其他 (可定制)
	天线罩材料	ASA 防紫外线
	安装方法	螺母+3M泡棉胶
环境	工作温度	-40°C~+85°C
	相对湿度	高达95%
	防水等级	IP67 (欧盟标准IP67 EN 60529:1991+A1:2000+A2:2013+AC :2019 中国国标GB/T4208-2017)
	振动	10至55Hz, 1.5mm振幅, 2小时
	环保	符合ROHS标准
	防紫外线	是

## 安装指引

- 1 请使用提供的L形状支架安装此天线
- 2 如果L型支架对安装空间过大, 请安装天线在至少56mm\*56mm尺寸的金属板上, 低频可能会受影响
- 3 无L支架情况下, 推荐的金属板尺寸为100mm\*100mm

# 迈斯维高增益蜂窝天线700-6000MHz支持 5G/4G/WiFi6 IP67防紫外线螺母3M双安装

AN\_GSM\_401

## 测试结果

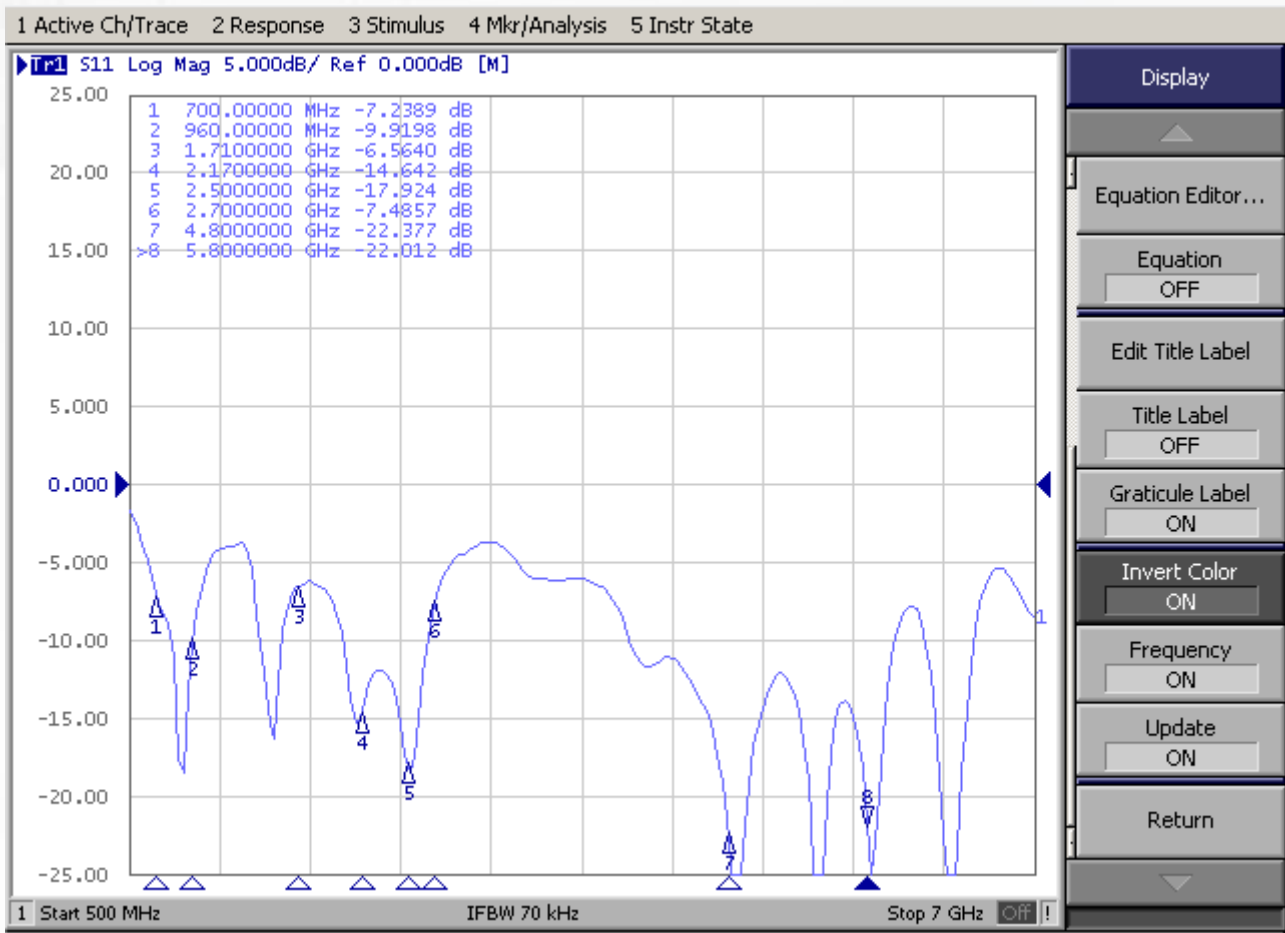



# 迈斯维高增益蜂窝天线700-6000MHz支持 5G/4G/WiFi6 IP67防紫外线螺母3M双安装

AN\_GSM\_401

## 实测数据

Passive Test For 600-6000		
Freq (MHz)	Effi (%)	Gain (dBi)
600	24.18	-1.98
650	28.66	-2.64
700	38.42	-0.03
750	56.43	-0.28
800	62.93	2.3
850	59.67	0.41
900	56.84	0.89
950	46.23	0.78
1000	48	2.11
1050	54.69	3.47
1100	45.41	2.14
1150	31.19	0.45
1200	24.71	-2.53
1250	22.83	-3.22
1300	20.94	-3.43
1350	24.62	-1.49
1400	28.01	-0.77
1450	40.75	0.16
1500	39.39	-0.8
1550	43.11	-0.65
1600	50.35	1.08
1650	54.81	0.94
1700	46.27	1.52
1750	47.97	0.75
1800	47.78	1.03
1850	53.33	1.81
1900	66.26	3.26
1950	66.14	4.01
2000	64	3.87
2050	65.18	4.29
2100	68.07	4.56
2150	52.51	3.63
2200	51.88	3.52
2250	55.44	3.62

Passive Test For 600-6000		
2300	59.35	4.23
2350	63.99	4.7
2400	63.95	4.55
2450	59.72	4.65
2500	64.69	4.45
2550	60.8	4.11
2600	57.3	4.05
2650	55.94	3.94
2700	51.22	3.52
2750	47.38	3.43
2800	61.15	4.92
2850	56.43	5.05
2900	51.58	4.85
2950	50.25	5.12
3000	49.22	5.07
3050	49.62	5.15
3100	54.6	5.55
3150	54.15	5.25
3200	60.86	5.69
3250	66.65	6.15
3300	71.28	6.33
3350	78.36	6.39
3400	78.3	6.09
3450	74.56	5.66
3500	68.58	5.35
3550	65.7	5.11
3600	68.4	5.36
3650	68.61	5.37
3700	62.37	4.67
3750	62.4	4.66
3800	58.95	4.59
3850	62.41	4.72
3900	68.67	5.11
3950	70.61	5.17
4000	77.22	5.36
4050	76.74	5.24
4100	76.44	5.11

Passive Test For 600-6000		
4150	79.19	5.15
4200	74.83	4.82
4250	74.42	4.58
4300	73.49	4.69
4350	68.53	4.32
4400	70.95	4.43
4450	68.01	4.15
4500	70.9	4.33
4550	69.68	4.22
4600	63.7	3.89
4650	65.16	4.09
4700	64.52	4.12
4750	60.22	4.02
4800	62.13	4.31
4850	56.51	3.93
4900	55.12	3.86
4950	51.97	3.56
5000	51.65	3.44
5050	46.26	2.77
5100	47.85	2.76
5150	45.8	2.27
5200	44.69	2.01
5250	49.25	2.39
5300	49.25	2.45
5350	53.34	3
5400	55.58	3.25
5450	52.45	3.19
5500	51.66	3.28
5550	52.37	3.65
5600	52.08	3.7
5650	53.99	3.85
5700	55.02	4.1
5750	56.92	4.23
5800	54.19	4.15
5850	56.85	4.46
5900	51.74	4.17
5950	65.46	5.12
6000	62.48	4.29

# 迈斯维高增益蜂窝天线700-6000MHz支持 5G/4G/WiFi6 IP67防紫外线螺母3M双安装

AN\_GSM\_401

## 700Mhz

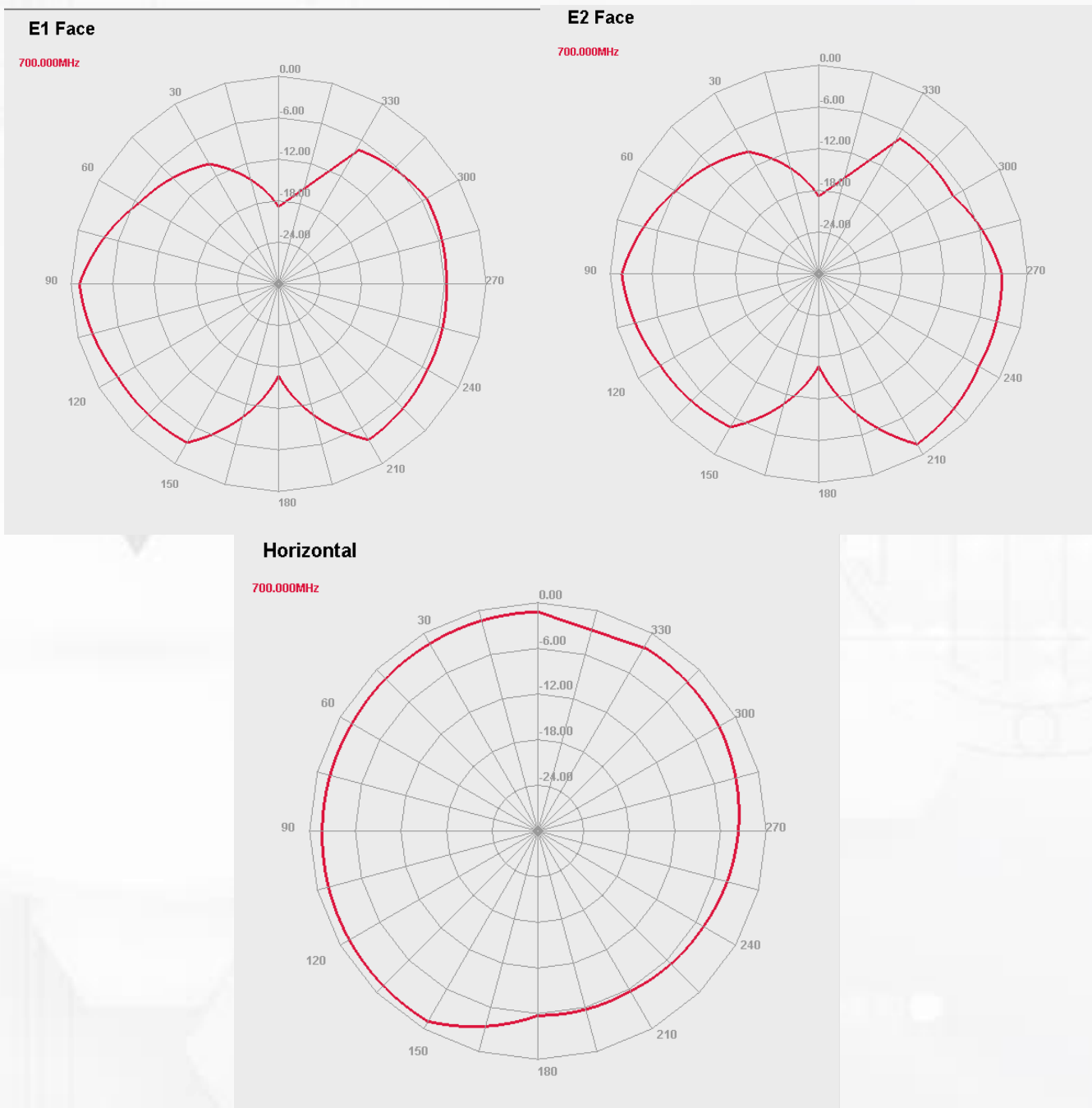

# 迈斯维高增益蜂窝天线700-6000MHz支持 5G/4G/WiFi6 IP67防紫外线螺母3M双安装 AN\_GSM\_401

## 1800Mhz

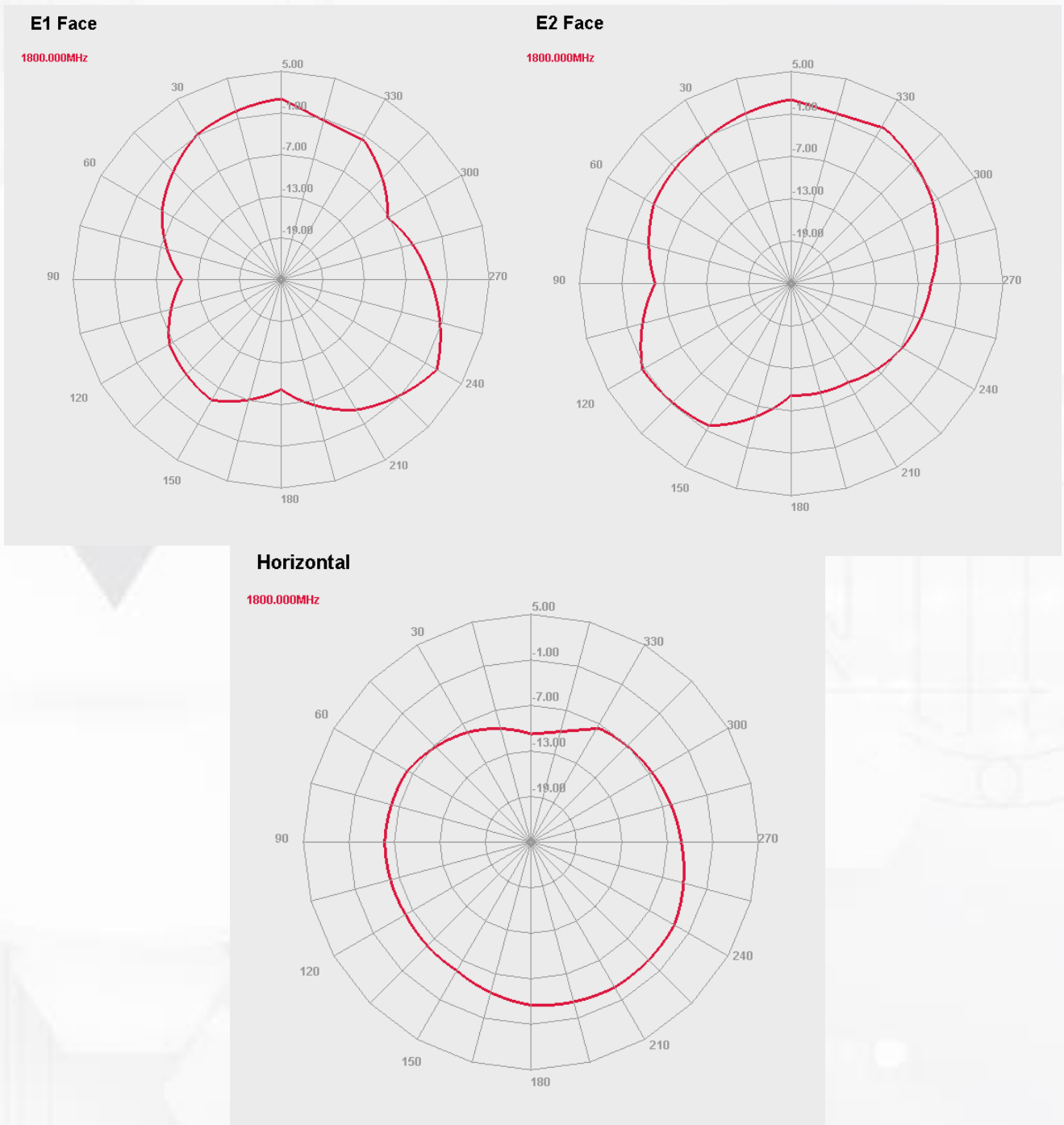

# 迈斯维高增益蜂窝天线700-6000MHz支持 5G/4G/WiFi6 IP67防紫外线螺母3M双安装

AN\_GSM\_401

2600Mhz

**E1 Face**

2600.000MHz

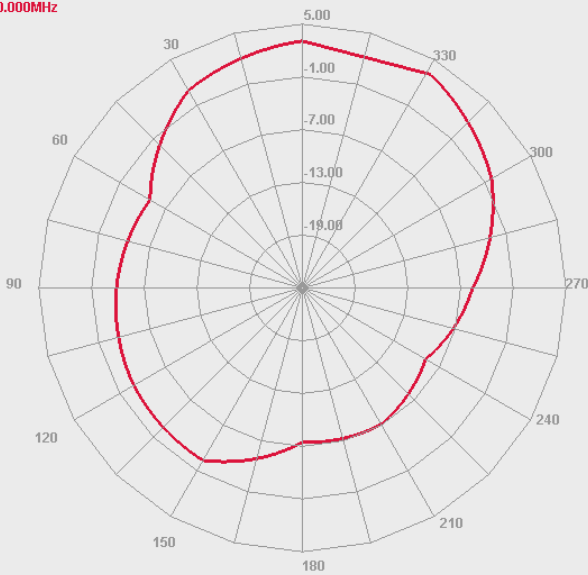

**E2 Face**

2600.000MHz

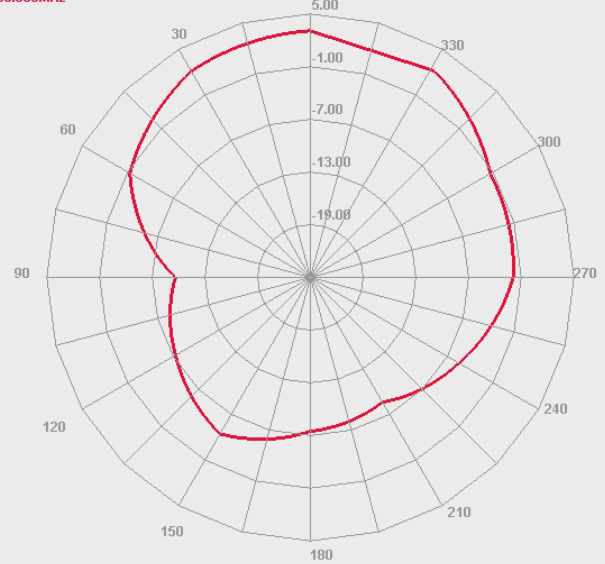

**Horizontal**

2600.000MHz

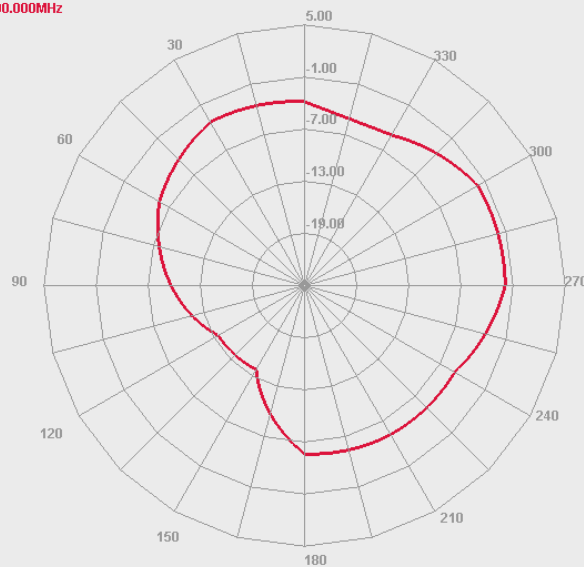

# 迈斯维高增益蜂窝天线700-6000MHz支持 5G/4G/WiFi6 IP67防紫外线螺母3M双安装 AN\_GSM\_401

3500Mhz

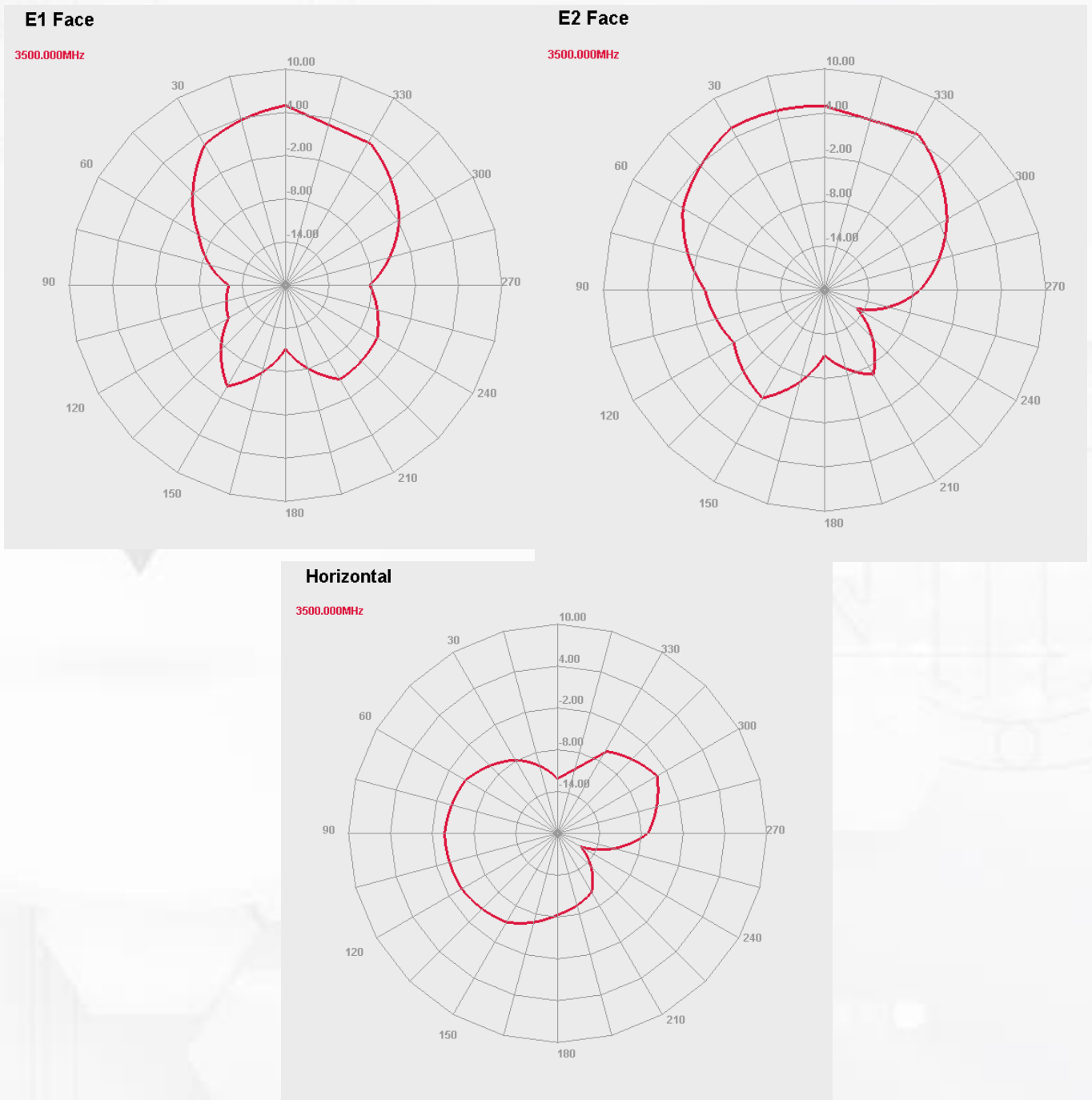



# 迈斯维高增益蜂窝天线700-6000MHz支持 5G/4G/WiFi6 IP67防紫外线螺母3M双安装

AN\_GSM\_401

4800Mhz

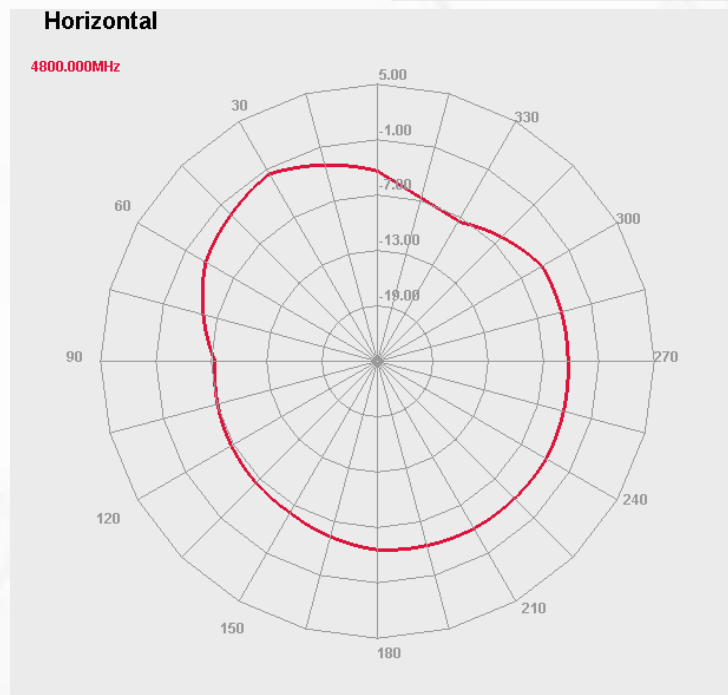
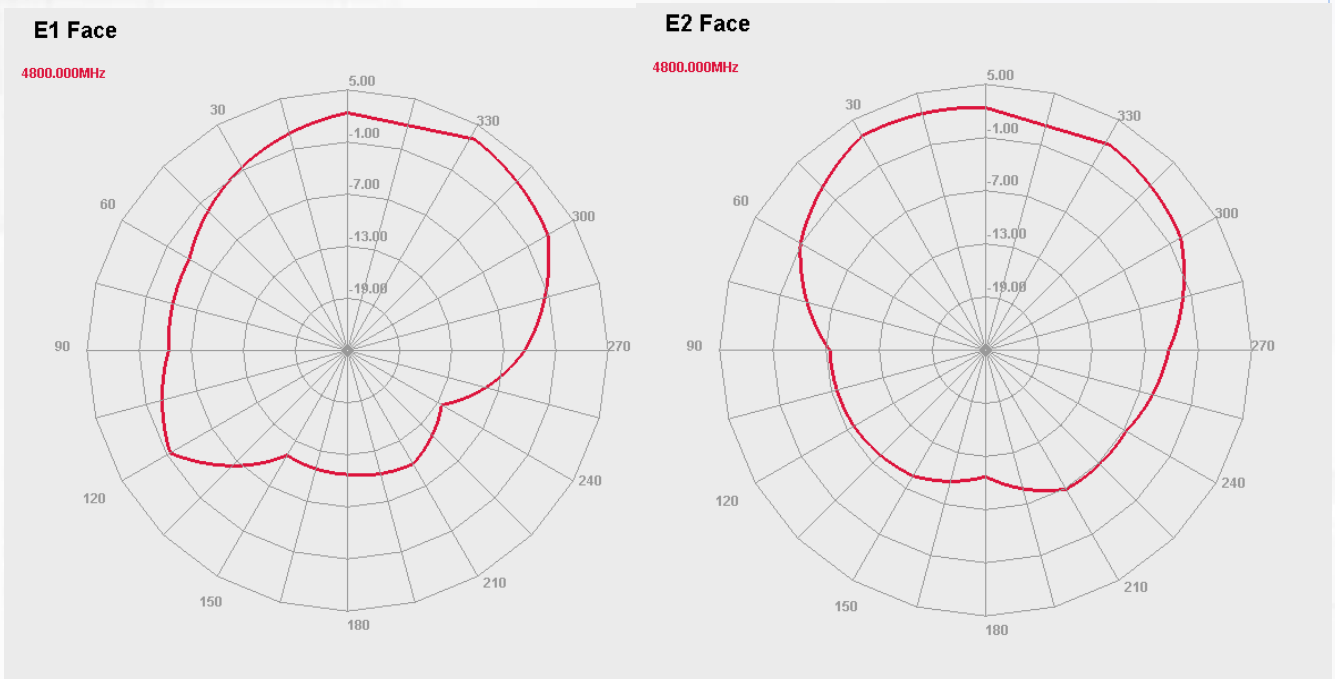

# 迈斯维高增益蜂窝天线700-6000MHz支持 5G/4G/WiFi6 IP67防紫外线螺母3M双安装

AN\_GSM\_401

5800Mhz

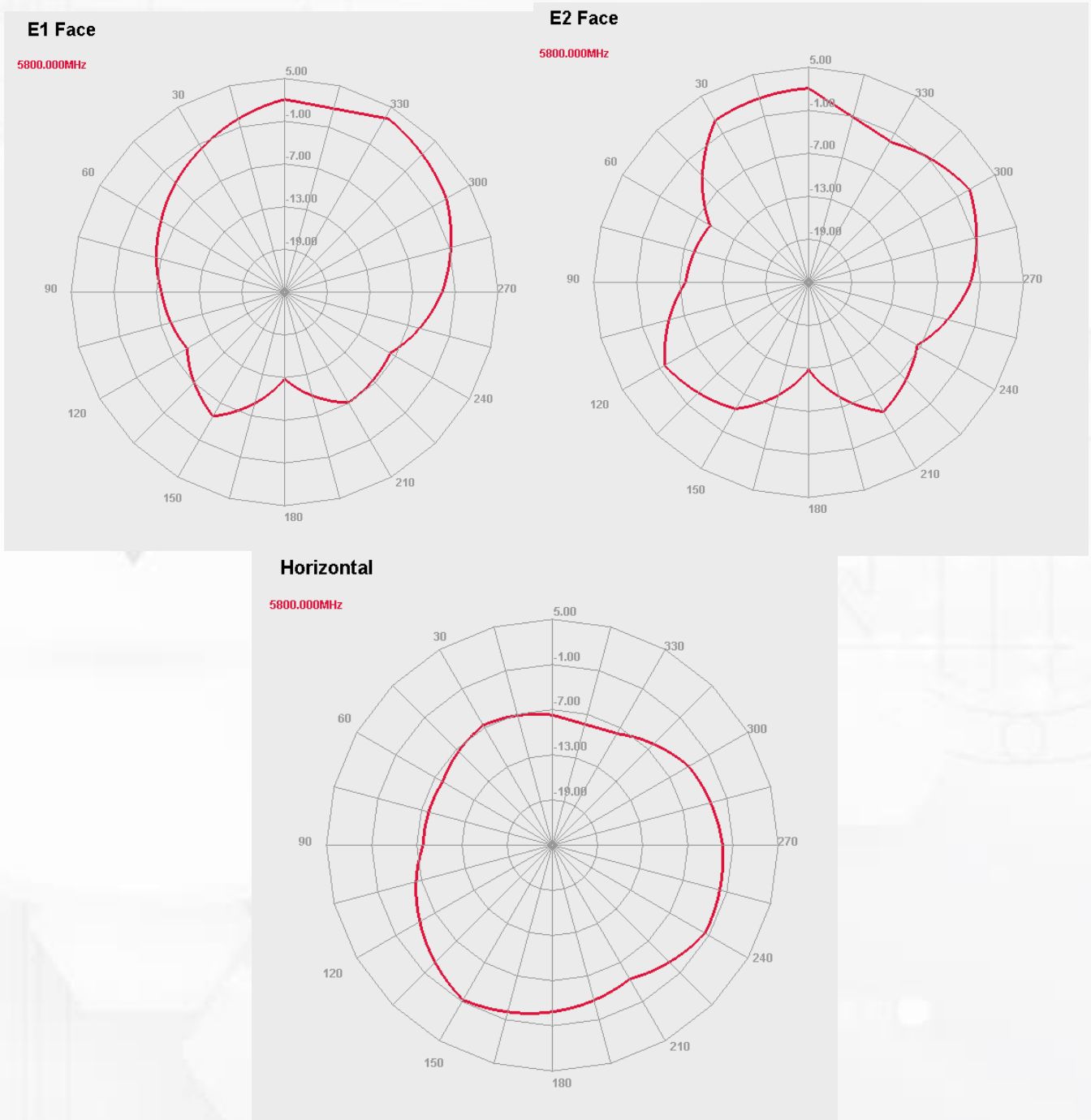

# 迈斯维高增益蜂窝天线700-6000MHz支持 5G/4G/WiFi6 IP67防紫外线螺母3M双安装

AN\_GSM\_401

**600.00MHz - 6000.00MHz Gain**

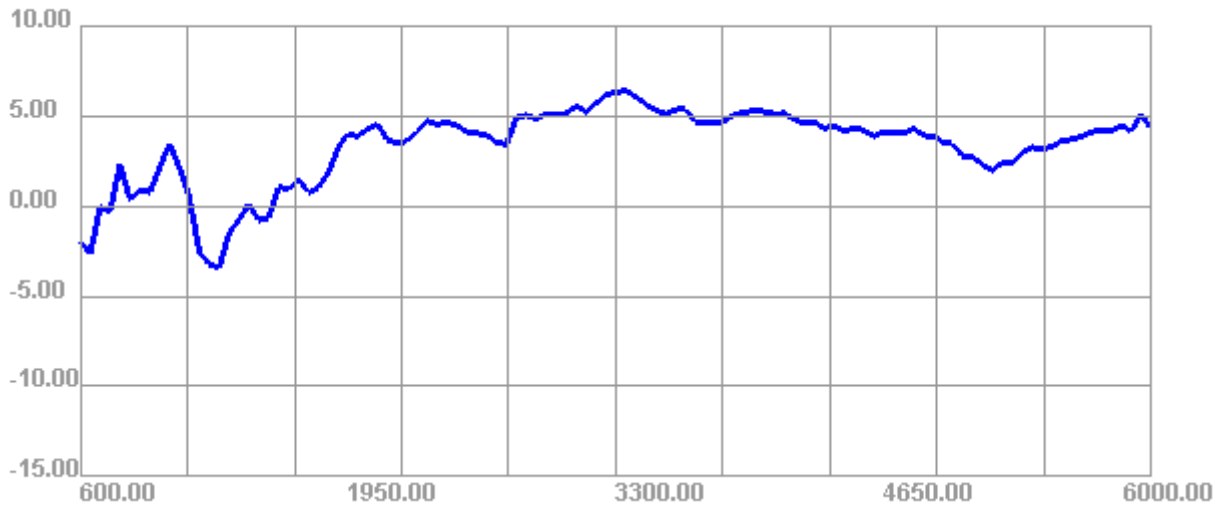

**600.00MHz - 6000.00MHz Efficiency**

