

# GPS+4G+WIFI 圆形组合天线螺母安装

AN\_GPS\_GSM\_WF\_046.2

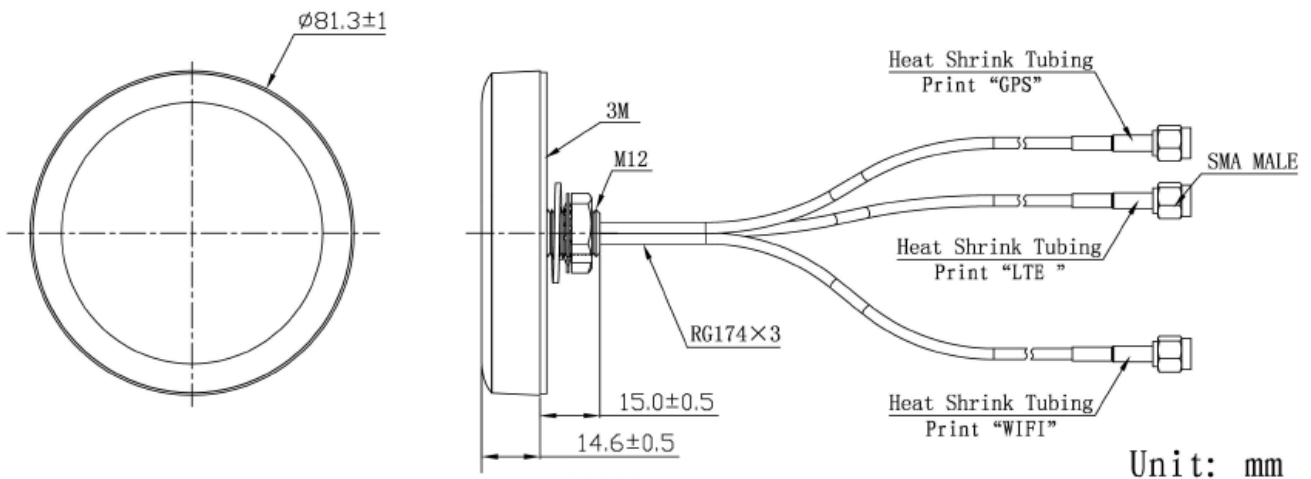

## 机械尺寸



## GPS+4G+WIFI 圆形组合天线螺母安装

### 规格

项目		规格	
GPS天线	电介质天线	中心频率	1575.42±3MHz
		带宽	CF±5MHz
		极化	右旋圆极化
		增益	2dBic (最高值)
		V.S.W.R	< 1.5
		阻抗	50Ω
		轴比	3dB (最大值)
	低噪声放大器	增益	28±2dB
		噪声因数	<1.5dB
		V.S.W.R	< 2.0
	电源电压	2.2~5V 直流	
	电流消耗	<15mA	
GSM天线	频率范围	698~960MHz/1710~2670MHz	
	V.S.W.R	< 2.0	
	极化	线性	
	增益	2.0dBi	
	阻抗	50Ω	
WIFI天线	频率范围	2400~ 2483.5MHz/4900~5825MHz	
	带宽	83.5MHz/925MHz	
	极化	线性	
	增益	3dBi	
	V.S.W.R	<2.0	
	阻抗	50Ω	
机械	电缆	RG174	
	连接器	4G/GPS :SMA 公 WiFi: RP SMA Plug	
	材料	ABS	
	安装方法	螺母	

## GPS+4G+WIFI 圆形组合天线螺母安装 规格

环境	工作温度	-40°C~+85°C
	相对湿度	高达95%
	入口保护	IP65~IP66 (不含电缆插座)
	振动	10至55Hz, 1.5mm振幅, 2小时
	环保	符合ROHS标准

# GPS+4G+WIFI 圆形组合天线螺母安装

## 辐射方向图

GPS部分方向图

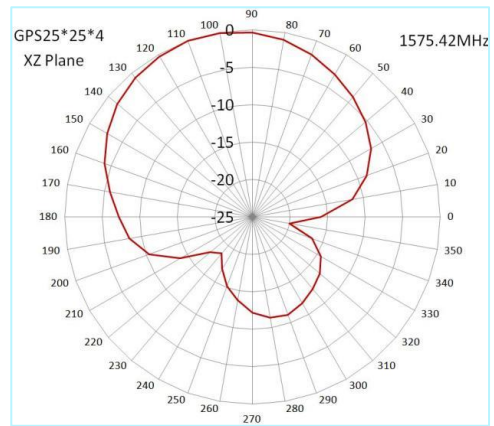
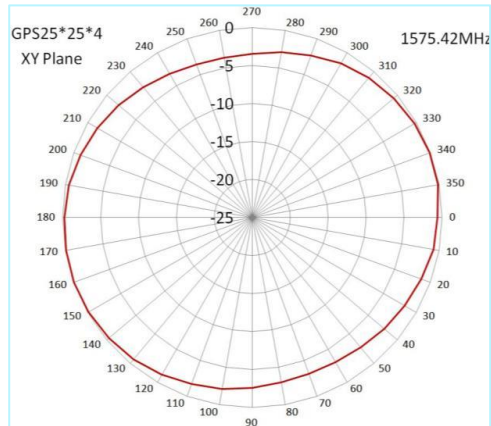

GSM部分方向图

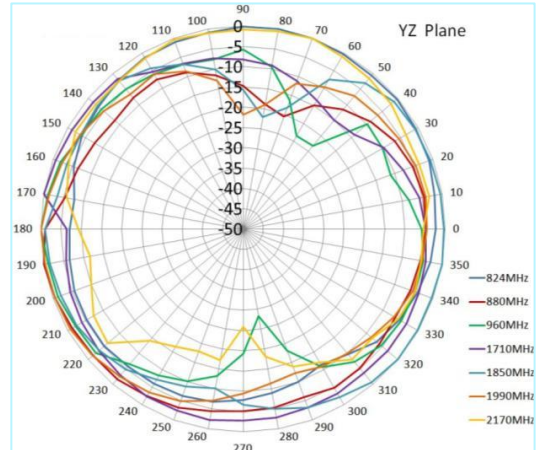
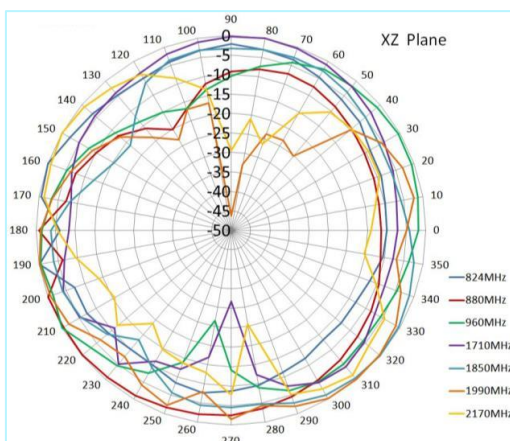
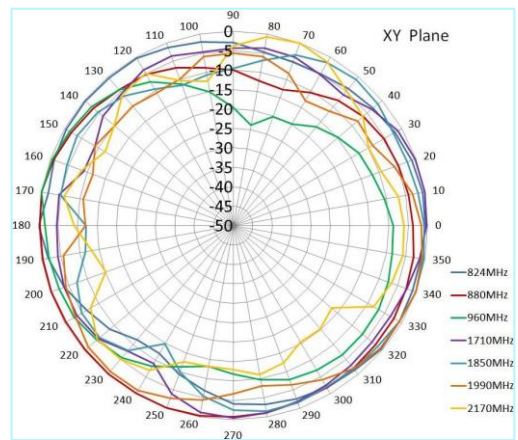
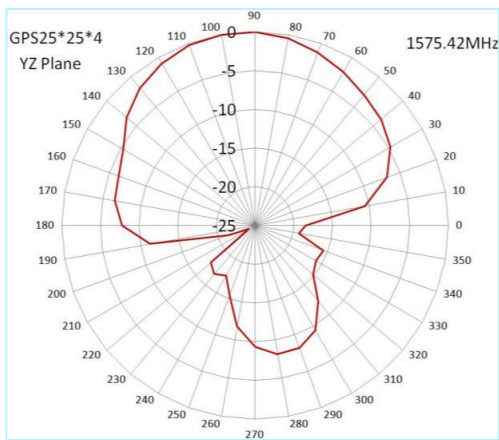

# GPS+4G+WIFI 圆形组合天线螺母安装

## 辐射方向图

WIFI部分方向图

